



<b>Engine</b>	Cummins B6.7, Stage V
<b>Net Power</b>	168 kW (225 hp / 228 ps) @ 2,000 rpm
<b>Operating Weight</b>	19,870 kg (43,805 lbs)
<b>Bucket Capacity</b>	2.6 – 5.6 m <sup>3</sup> (3.4 - 7.3 yd <sup>3</sup> )

# 856H WHEEL LOADER

# TOUGH WORLD. TOUGH EQUIPMENT.

You don't need to be told it's a tough world. It's your reality, you live it every day and you know how hard it can be on your people and your machines. It's getting tougher to make your business pay too, with rising costs, increasing legislation and greater competition. We understand and we've put that understanding into action with our new 856H.

## 856H. NO TOUGH COMPROMISES, JUST EVERYTHING YOU NEED AND NOTHING YOU DON'T

The construction equipment industry has seen an expensive trend towards over-engineered products. Some manufacturers genuinely believe that adding cost, adds perceived value in customers' eyes.

## BUT YOU TOLD US A DIFFERENT STORY

You asked for a tough, well-engineered wheel loader, which just keeps on working, cycle after cycle.

### YOU WANTED A ROBUST WHEEL LOADER THAT DELIVERS ON 3 ESSENTIAL NEEDS;

1



**HEAVYWEIGHT CREDIBILITY**

2



**UPTIME AND SUPPORT**

3



**TOTAL COST OF OWNERSHIP**



With the new 856H, we've risen to your challenge and given you everything you want – a tough, credible wheel loader – built without compromise.



## TOUGH FACTS

### AWARD WINNING DESIGN

Our UK-based design team has invested thousands of man hours to really understand how our machines are used every day. This insight shapes our innovative approach to product design. Our design team recently won a prestigious Red Dot Award for our D-Series Grader and all our products this award-winning design DNA.

### TOUGH RESEARCH AND TESTING

Finding tougher, smarter, safer and more cost-effective ways of working matters to you. It matters to us too. Our new Global Research & Development Centre is a great example of this customer focused approach. We've established an international team of industry experts, backed up with the latest world-class technology, all focused on delivering greater value to you.

### TOUGH QUALITY STANDARDS

When it comes to quality, we let our actions to speak for themselves.

We follow a rigorous Six Sigma methodology and consistently achieve ISO 9001 standards.



# HEAVYWEIGHT CREDIBILITY

In tough quarrying and mining environments, there's no room for guesswork. You need to know that your wheel loader can easily handle all the strenuous day-to-day tasks with speed, economy and unending stamina. Your business credibility ultimately depends on your machine's operating performance and with our new 856H you can be sure that your reputation is in safe hands.

## 1 HEAVYWEIGHT POWER

At the heart of our exceptional powertrain lies the latest Cummins B6.7 engine. This power house has been designed to deliver impressive acceleration and torque output, along with a serious bucket filling and lifting capability which greatly increases cycle times and earning potential. As you would expect, with a net power of 168 kW (225 hp / 228 ps), the QSB engine fully complies with EU Stage V emission standards.

## 2 HEAVYWEIGHT COMBINATION

Faster cycle times are made easy with the 856H's power combination. Our engine is teamed up with ZF smooth shifting transmission. This combination optimizes power and fuel efficiency, day after day, increasing bucket breakout force and loading capability. To this, we've added larger, high capacity axles which make light work of the toughest terrain and intelligent hydraulics for low-engine speed performance, quick steering response and rapid boom up speeds. We put this power right in your operator's hands with simple and intuitive controls designed to get the job done faster and more effectively every cycle.

## 3 THE CAPABILITY TO LIFT MORE FOR LONGER

Our new H Series buckets load heavy materials easier and faster; saving you time, lowering fuel consumption and reducing damage. In tests, our new buckets increase production by 14% and lower fuel consumption by 15% per hour. In addition, damage to the bucket and teeth can be greatly reduced thanks to the stronger anti-wear blade.

## 4 PROVEN ZF AXLE PERFORMANCE

Stability, traction and weight loading capability are the 3 key essentials for axles in heavy applications. Our new ZF axles with limited-slip differentials excel in handling heavy loads up to 22T static and 18T dynamic in tough terrain. The intelligent, responsive power combined with excellent traction and stability give operators a real feeling of confidence on any ground – soft and shifting or hard and unforgiving.

## 5 NEW Z-BAR ENHANCEMENTS

Careful distribution of stress loads increases the Z-bar's tolerance significantly. Hinge pins and lift arm mounting plates have been strengthened, while optimized Z-Bar geometry improves bucket breakout force, operator visibility, loading stability and speed.



## 6 SAFETY CREDENTIALS

When it comes to operator safety our cabs are second to none. ROPS and FOPS safeguard your operator, but we've gone further, increasing stability to prevent roll overs happening in the first place. As a result, operators can relax and be confident in the integrity of their machine, no matter how unstable the terrain.

## 7 HEAVYWEIGHT BACKBONE

The chassis frame is the backbone of the machine, so it's got to be tough. Our rigorous design and testing regime has delivered a chassis capable of absorbing all the forces and pressures of the toughest most demanding environments. Hour after hour, day after day, year after year, our chassis stay strong, protecting the driveline, your operator and your profitability.

## 8 NEW DIESEL TANK

A new larger, better protected and more efficient 270 liter fuel tank keeps the 856H working harder for longer. Its well-positioned suction line achieves 96% utilization even on steep slopes. In addition, diesel cooling reduces vapor, lowers temperature and increases overall fuel efficiency.

## 9 15% AIRFLOW IMPROVEMENT

A new grill, a larger more efficient cooling fan and a newly redesigned radiator all combine to deliver a 15% improvement in ventilation. Whatever the conditions, you can be confident that the 856H will always keeps its cool when the going gets tough.



## TOUGH JUDGES

Wheel loader operators are tough judges. They know what they like and what they don't. We've talked, we've listened and we've delivered a no-nonsense wheel loader that will do everything the operator wants and needs it to do. **Job done? Judge for yourself.**

# 500,000

## SHARING OUR CUSTOMERS' SUCCESS

No matter what we say or how passionately we argue our case, ultimately heavyweight credibility comes down to one unavoidable question.

**Can our machines really cut it in the real world?**

**Our answer?**

Ask the satisfied owners of the **500,000** LiuGong wheel loaders already delivered. Their trust in our knowledge, their satisfaction in our product and their loyalty, have made LiuGong one of the world's largest wheel loader manufacturers.

Don't take our word... take theirs.



# MACHINES DELIVERED



## GET'S THE JOB DONE

I have been the operator of this LiuGong wheel loader since the company purchased it three years ago... It is used day in, day out, eight-to-ten hours a day, five and sometimes six days a week.

Even though stone mines are tough on machinery we have not had any major problems. Age has not effected the controls; they are still just as reactive and the engine and lifting performance is still as strong as the day it arrived.

**Eszak Terko Ltd – Hungary**

## A CREDIBLE CHOICE

Even though we know that Chinese brands will be future leaders in the construction industry, we were a little uncertain about what LiuGong could offer, so we did a lot of research online before committing to the purchase. We found that LiuGong is a major player globally and that most of the technical components are from Western Europe so there is very little risk.

If we do have a problem, there is a European parts warehouse in Poland and the local dealer provides good support.

**Van Dijk Infracgroep – the Netherlands**







# POWER YOU CAN TRUST

Heavyweight credibility is about giving your operators unshakable confidence in their machine and its ability to handle the toughest and heaviest jobs. That's what we do. Our endurance testing exposes our machines to over 30,000 hours of relentless stress testing, to prove that when it comes to credibility, actions speak louder.

## POWER WITHOUT WASTE

Environmental as well as economic awareness lie at the heart of our new 856H. Powered by the latest fuel efficient Cummins engine, it has a net power rating of 168 kW (225 hp / 228 ps) @ 2,000 rpm and fully complies with EU Stage V emission standards without compromising on power or performance.

For operational efficiency, the engine uses a precise, high pressure common-rail fuel injection system, turbo charger (VGT) and air-to-air intercooler, along with electronic engine controls to deliver optimal performance in every cycle in every shift. Engine emissions are virtually eliminated by NOx and Dual reduction Technology, ensuring that the 856H delivers, both for the environment and the bottom line.



## INTELLIGENT AUTO-IDLE SPEED CONTROL

Fuel consumption and emissions are closely linked to engine speed – the greater the control and optimization, the lower the fuel consumption and emissions. Intelligent Auto-Idle Speed cleverly matches engine speed and RPM with the job in hand and will automatically switch to idle speed in between actions, greatly improving environmental and economic performance.

## KEEPING IT COOL AND CLEAN

Inefficient engine cooling has a negative effect on fuel economy and emissions. We have focused our design experience on greatly improving the engine cooling system. The new 6 mm hexagon grill improves ventilation while a new reversible hydraulic fan, increases cooling efficiency with the flick of a button.



## SMART FUEL ECONOMY (SAVE UP TO 4 L)

The intelligent combination of powerful digging force, swing torque and lifting performance make the most of every drop of fuel. The 856H maximizes fuel economy by intelligently regulating its idle speed by the second.



**1 second:** If no hydraulic request signal detected from the joystick, the engine speed is automatically dropped by 100 RPM, saving 1 liter of fuel every 2 hours.



**3 seconds:** If no activity is detected over three seconds the engine speed will decrease to idle.

In each case, as soon as the system detects the hydraulic signal once more, the engine will immediately return to the previous throttle speed setting. Our tests indicate that up to 4 liters of fuel can be saved on an 8-hour shift.

# HEAVYWEIGHT CREDIBILITY IS POWER IN ACTION

Power means nothing unless it can be intelligently employed to get the job done faster and better. Cycle after cycle it's about taking the power from the engine and delivering that power with force and efficiency to the loading tool.

## LOAD SENSING HYDRAULICS – POWER WHERE YOU WANT IT

Our hydraulic system delivers an impressively high breakout force of 187 kN with control and precision delivering power to where the operator really needs it. Lifting and cycle speeds are equally impressive at 5.3 seconds and 10.2 seconds, respectively. This is power where you need it, improving penetration, allowing simultaneous lift and tilt functions to be executed and reducing hydraulic waste.

## AUTOMATIC TRANSMISSION – ENHANCING OPERATOR PERFORMANCE AND FUEL ECONOMY

The 856H's automatic powershift transmission helps even the newest operator perform like a fuel wise professional matching the machine's performance perfectly to the job, whatever that job may be.

Two selectable options; Manual and Full auto, make it easier to do the job better, saving time and reducing fuel and emissions. The lock up clutch torque converter also aids performance fuel economy by delivering the maximum amount of power to the transmission.

## RIDE CONTROL – POWER AND COMFORT

Heavyweight work can be tough on man and machine. LiuGong's next generation ride control, teamed with automated bucket positioning sets the new benchmark for heavy lifting applications. Loading shocks and impacts are greatly reduced, that's good news for operators and for the machine's longevity. Smoother load handling and manoeuvrability around the site has been noticeably improved with material spillage greatly reduced, leading to faster, more productive cycle times, reduced fuel consumption and higher operator performance and satisfaction.

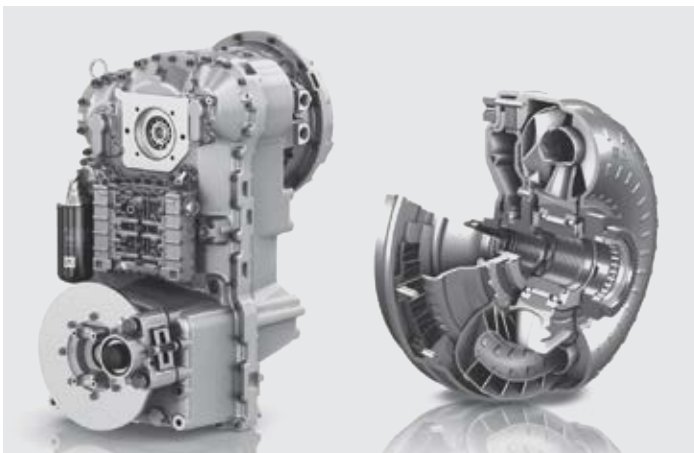



# DESIGNED TO MAKE TOUGH WORK EASY ON THE OPERATOR

Climb into the cab of the 856H and you can see that it has been designed by someone who has operated a machine in really tough conditions and who knows the importance of excellent visibility.

For a start, 5-Bar stamped steps with a 10° ergonomic incline and improved anti-slip tread make the 856H safe and easy to get in and out of.

Well-placed door handles, safety rails and anti-slip tape on the upper part of the machine make it easier and safer for operators to enter and exit the cab safely in all weathers and conditions.

Inside, the cab is secure and protected with space to work and excellent visibility from the redesigned windows and effective mirror and rear view camera combinations which improve overall visibility by 15%.

The controls including, joystick or finger control levers are where the operator needs them to be. They are easy to see, easy to

reach and easy to handle.

The multi-adjustable air-suspension seats are comfortable and designed to keep the operator fresh and alert.

## WE PUT OPERATORS FIRST

It makes good business sense to give operators the very best working environment – a comfortable operator is a productive operator.

The 856H keeps operators safer, more alert and more productive.



The cab protects the operator from noise and vibrations and is well ventilated. It has advanced climate control to handle the changing seasons and is completely sealed to prevent dust from entering the work place.

## HEAVY WORK – NO SWEAT

An advanced climate control system with eight all-round vents, five selection modes and 6 kW of cooling capacity, creates the perfect working environment whatever the weather.

Easy-to-replace air filters eliminate dust and prevent particles from polluting the cab.

## CONTROL IN THE OPERATOR'S HANDS

We believe in making life easy for the operator which is why we've positioned the kick-down and forward/reverse buttons on the joystick.

The kick-down function gives the operator finger-tip control enabling him to lower the gear, increase engine torque and maximize bucket breakout force with the minimum of effort.



# DAILY CHECKS AND MAINTENANCE SHOULDN'T BE TOUGH

Simple daily checks and maintenance prolong machine performance but, they can be difficult and time consuming on tough jobsites where time is precious.

## Not with the 856H.

The electrically actuated, wide opening fiberglass hood gives fast and easy access to the engine and regular service points – that's good news for operators who want to reduce maintenance time to the minimum.

### ONBOARD MONITORING

With on board monitoring, the operator can check the machine's vital signs; oil temperatures and pressure levels, receive service interval alerts and access all the information that contributes to simple maintenance and servicing of the machine, right from his seat.



Maintenance speed and access is further improved with sturdy handrails, fitted as standard, which enable safe and easy access to the upper structure.



### EASILY ACCESSIBLE SERVICE POINTS MAKE DAILY CHECKS FAST AND EFFECTIVE

- Easily visible hydraulic oil level gauge
- Ground accessible, grouped filters
- Easy to reach electronic control box
- Easy to replace A/C filter next to the cab door





# JOBSITE UPTIME AND SUPPORT

Heavyweight credibility might convince you to buy your first machine, but it's uptime and support and total cost of ownership which will keep you coming back to buy more machines. Having confidence in the machine's back up and support network is a vital part of the purchasing decision. How do we at LiuGong measure up?

## FAST RESPONDING GLOBAL NETWORK

We have an extensive dealer network of over 300 dealers in more than 100 countries.

All supported by 13 regional subsidiaries and 17 regional parts depots offering expert training, parts and service support.



**WE ARE LIUGONG. WORKING HARD TO KEEP OUR GLOBAL CUSTOMERS EARNING**

- 14,000+ Employees
- 20 Factories
- 13 Regional subsidiaries
- 300+ Dealers
- 1,000+ R&D engineers
- 5 R&D facilities
- 17 Regional parts depots
- Over 60 Years' experience



## WHERE YOU NEED US WHEN YOU NEED US

Reliability is built into our machines but all machines have some planned downtime. Our aim is to reduce even planned down time to the minimum by getting it right. Technician training and parts availability are also high on our agenda, as is keeping you

informed on service and maintenance work and providing clear and accurate estimates, invoices and communication.

These may be small things, but customer feedback tells us that these basics really matter – so we aim to get them right.

## MAINTENANCE AND SUPPORT PACKAGES

From genuine LiuGong parts, to full repair and maintenance contracts, LiuGong has the flexibility to offer the level of support and response to suit your business and applications. Whatever level of support you choose you can be confident that it is backed up by LiuGong's service promise.



**Right parts.  
Right price.  
Right service.**

**Above all,  
we get it right  
the first time.**

# 1<sup>st</sup>



## LIUGONG SERVICE PROMISE



Highly trained technicians utilizing the latest diagnostic equipment



15,000+ Genuine LiuGong parts available within 24hrs from our European Parts Distribution Center



Multi-lingual Service helpline and online support



Transparent estimates and invoicing



Clear communications through electronic parts catalogue



# TOTAL COST OF OWNERSHIP

Heavyweight credibility and uptime and support are two key wheel loader purchasing criteria but ultimately, the machines earning potential, its overall life cost and its trade-in value really matter too.

When it comes to total cost of ownership LiuGong has a strong story to tell.

## PROFESSIONAL ADVICE

We are committed to reducing your total cost of ownership and increasing your profits. As part of this, LiuGong's experts will provide targeted advice on everything, from choosing the right machine for your needs to maximizing its efficiency on site.

## MACHINE AVAILABILITY

Our machines deliver everything you need and nothing you don't. They are expertly engineered NOT over engineered. As a result of having an extensive manufacturing operation right in the heart of Europe, we can offer significantly shorter lead times on

a range of models, compared with some manufacturers. In fact, we can deliver selected machines in as little as 4 weeks.

The faster you can get a machine – the faster you can get working and earning.

Our aim is to get you on to the jobsite fast.

## TICKET PRICE

At LiuGong, our aim is to provide you with real, measurable value by giving you everything you need and nothing you don't. We choose high quality, proven components and parts from world-renowned brands and suppliers.

These proven components, combined with LiuGong design and manufacturing quality, result in a high quality, competitive machine that is totally fit for purpose.

## RESIDUAL VALUE

With the combination of LiuGong design and manufacturing excellence, world class components and comprehensive uptime support, our quality holds its value.





## IT ALL ADDS UP

With the 856H we've risen to the challenge and given you everything you need and nothing you don't.

It's a wheel loader which can handle any job, anywhere, backed up by LiuGong's service promise and designed to perform on the jobsite and on the balance sheet. Add up the benefits and you'll see that 856H represents the formula for success.



**HEAVYWEIGHT CREDIBILITY**

+

**UPTIME AND  
SUPPORT**

+

**TOTAL COST  
OF OWNERSHIP**

---

**CUSTOMER SATISFACTION**

---

# SPECIFICATIONS

## Operating weight 19,870 kg (43,805 lbs)

Operating weight includes the machine weight with standard work device, no additional equipment or accessories, full fuel tank, all fluids at required level and an operator 75 kg (165 lbs).

Bucket capacity 2.6 - 5.6 m<sup>3</sup> (3.4 - 7.3 yd<sup>3</sup>)

## ENGINE

### Description

Cummins EU Stage V-approved, 6.7 liter (1.8 gal), 6-cylinder straight turbocharged diesel engine with common rail fuel injection system. Cummins Variable Geometry Turbocharger (VGT) improves engine response at both low and high speed RPM.

Cummins CM2350 (improved microprocessor and memory) ECM lever latch connections. Integrated DEF controller.

Auto idle – saves fuel, idle time is 10 mins, idle speed at 700 rpm.

Air cleaning: Cummins direct flow air filter.

Cooling system: Air-to-air intercooler, hydraulic motor drive and temperature controlled fan.

Emission rating	EU Stage V
Make	Cummins
Model	B6.7
Engine Output - Max Gross (SAE J1995 / ISO 14396)	183 kW (245 hp / 249 ps) @ 1,700 rpm
Engine Output - Rated Net (SAE J1349 / ISO 9249)	168 kW (225 hp / 228 ps) @ 2,000 rpm
Peak torque	1,186 N·m (874 lbf-ft)
Displacement	6.7 L (1.8 gal)
Number of cylinders	6
Aspiration	Turbocharged & Air-to-air intercooled

## SERVICE REFILL CAPACITY

Fuel Tank	270 L (71.3 gal)
Engine Oil	18 L (4.8 gal)
Cooling System	44 L (11.6 gal)
Hydraulic System	252 L (66.6 gal)
Transmission and Torque Converter	35 L (9.3 gal)
Axles, Each	44 L (11.6 gal)
DEF Tank	49.2 L (13.0 gal)

## TRANSMISSION

### Standard

Torque converter: single-stage, three elements.

Transmission: ZF 4BP 210 countershaft transmission, integrated pilot single joystick with FNR, KD and horn. Electro proportional valve, continuous power in gears shift and less compact.

Gearshifting system: ZF Automatic Power Shift with auto modes all start in gear 2, faster and better for long distance material transport.

Transmission type	Countershaft, power shift
Torque converter	Single stage, three elements
Max. travel speed, fwd	38 km/h (23.6 mph)
Max. travel speed, rev	25.3 km/h (15.7 mph)
No. of speed, fwd/rev	4/3

### Option

Torque converter: single-stage, three elements. Lock up clutch torque converter  
Transmission: ZF 5WG 210 countershaft transmission, integrated pilot single joystick with FNR, KD and horn. Electro proportional valve, continuous power in gears shift and less compact.

Gearshifting system: ZF Ergopower Power Shift with auto modes, all start in gear 2, faster and better for long distance material transport.

Transmission type	Countershaft, power shift
Torque converter	Single stage, three elements, lock up clutch
Max. travel speed, fwd	38.8 km/h (24.1 mph)
Max. travel speed, rev	27.8 km/h (17.3 mph)
No. of speed, fwd/rev	5/3

## AXLES

Model	AP3000 (Wet type)
Differential front type	Limited slip
Differential rear type	Limited slip
Axle oscillation	±12°

## HYDRAULIC SYSTEM

### Description

System supply: Two load-sensing axial piston pumps with variable displacement. The steering function always has priority.

Valves: Double-acting 3-spool valve. The main valve is controlled by a 3-spool pilot valve.

Lift function: The valve has four positions: lift, hold, lower, and float. Inductive/magnetic automatic boom kick-out can be switched on and off and is adjustable to two positions: bucket at ground Level and maximum reach full lifting height.

Tilt function: The valve has three functions: rollback, hold and dump.

Cylinders: Double-acting cylinders for all functions.

Filter: Full-flow filtration through 12 micron (absolute) filter cartridge.

Main pump type	Piston
Main relief pressure	22 MPa (3,191 psi)
Raise	5.3 s
Dump time	1.4 s
Float down time	3.5 s
Fastest total cycle time	10.2 s
Controls	Joystick or 3 levers

## BRAKES

### Description

Two independent brake circuits, disks out of rim, accurate control with the advanced main valve & piston pump.

Service brake type	Wet disc brake, two independent circuits
Service brake actuation	Fully hydraulic
Parking brake type	Manual electronic control
Parking brake actuation	Electro-hydraulic release

## STEERING

### Description

Steering system: Load-sensing hydraulic articulated steering.

System supply: The steering system has priority feed from a load-sensing axial piston pump with variable displacement, Dual-pump confluence & Steering priority.

Steering cylinders: Two double-acting cylinders.

Steering configuration	Articulated
Steering relief pressure	18 MPa (2,611 psi)
Steering cylinders	2
Cylinder bore	120 mm (5")
Rod diameter	50 mm (2")
Stroke	395 mm (1' 5")
Maximum flow	90 L/min (23.8 gal/min)
Maximum articulation	±38°
Smallest turn (over tire)	6,158 mm (20' 2")

## DIMENSIONS

E Ground clearance	431 mm (1' 5")
G Wheelbase	3,320 mm (10' 11")
H Cab height	3,450 mm (11' 4")
J Wheel tread	2,150 mm (7' 1")
K Width over tires	2,750 mm (9')
L Length with bucket down	8,744 mm (28' 8")
M Turn angle, either side	38°
P Rear angle of departure	29°
R <sub>1</sub> Turning radius, bucket carry	6,911 mm (22' 8")
R <sub>2</sub> Turning radius, outside of tire	6,158 mm (20' 2")
W Width over bucket	2,928 mm (9'7")

## ELECTRICAL SYSTEM

### Description

Central warning system is a centralized electrical system with central warning light and buzzer for following functions: Serious engine fault, Low steering system pressure, Interruption in communication (computer failure), Low engine oil pressure, High engine oil temperature, High charge-air temperature, Low coolant level, High coolant temperature, Low transmission oil pressure, High transmission oil temperature, Low brake pressure, Engaged parking brake, Brake charging failure, High hydraulic oil temperature.

Voltage	24 V
Batteries	2 x 12 V
Battery capacity	2 x 120 Ah
Cold cranking capacity, approx	850 A
Reserve capacity	230 min
Alternator rating	1,960 W / 70 A
Starter motor output	4.8 kW (6.4 hp)

## CAB

### Description

Instrumentation: All important information is centrally located in the central instrument panel and operator's field of vision. Large curved front glass, rear view camera and mirrors ensure great visibility.

Adjustable steering column, air suspension seat, armrest box and Denso A/C with all-around air outlets.

Pressurized cab with lower interior noise. The cab is tested and approved according to ROPS (ISO 3471), FOPS (ISO 3449).

## LOADER ARM PERFORMANCE

### Description

Tipping Load data is calculated with standard bucket at 3.1 m<sup>3</sup> (4.1 yd<sup>3</sup>) and operating weight at 18,600 kg (41,006 lb).

Tipping load - straight according to ISO 14397-1:2007	13,675 kg (30,148 lbs)
Tipping load - full turn according to ISO 14397-1:2007	11,875 kg (26,179 lbs)
Bucket breakout force	187 kN (42,039 lbf)
A Maximum hinge pin height	4,156 mm (13'7")
B Dump clearance at full height discharge	2,980 mm (9'9")
C Dump reach at full height discharge	1,207 mm (3'11")
D Maximum digging depth, bucket level	50 mm (2")
S <sub>1</sub> Bucket rollback at ground level	42.7°
S <sub>2</sub> Bucket rollback at carry	48°
S <sub>3</sub> Bucket rollback at maximum height	62.3°
S <sub>4</sub> Maximum dump angle at full height	45°





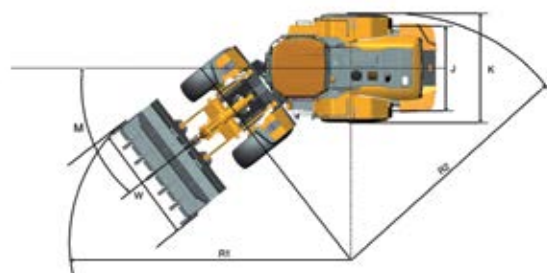
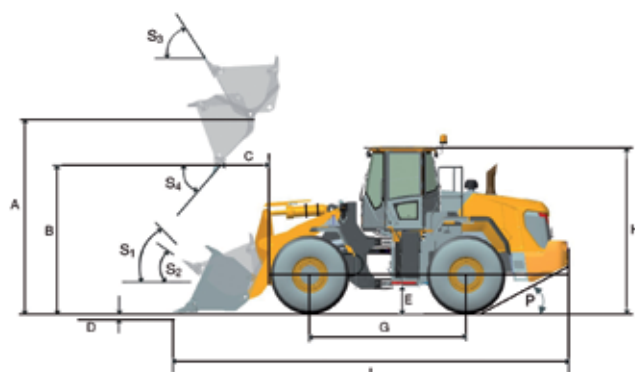



## SOUND & ENVIRONMENT

Sound level in cab according to ISO 6396-2008/EN ISO 3744-1995	69 dB(A)-- Travel mode
Sound level in cab according to ISO 6396-2008/EN ISO 3744-1995	70 dB(A)-- Stationary work cycle mode
External sound level according to ISO 6395-2008	105 dB(A)-- Travel mode
External sound level according to ISO 6395-2008	106 dB(A)-- Stationary work cycle mode
Ventilation	9.2 m <sup>3</sup> (12 yd <sup>3</sup> )
Heating capacity	5.8 kW (7.8 hp)
Air conditioning	6 kW (8 hp)



## TIRES



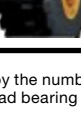

Choosing the right tyres for your machine will become a key competitive advantage to achieve outstanding performance. Through close engineering and development cooperation with renowned and carefully selected suppliers, LiuGong can offer full range of tyres specially tailored for wheel loader.

Code	Application	Patterns	Size	PR / *	Tube Type	Width	Overall Diameter	Tread Depth	Load Capacity, 50 km/h / 10 km/h (31.1 mph / 6.2 mph)
L2	<ul style="list-style-type: none"> <li>where good traction is needed, e.g. at grading work</li> <li>in soft and muddy operation where sharp stones don't occur</li> <li>in all load/carry operations</li> </ul>		23.5 - 25	12	TL	595 mm (1' 11")	1,615 mm (5' 4")	29.5 mm (1")	3,650 / 6,150 kg (8,046.9 / 13,558.4 lb)
			23.5 - 25	16	TL	595 mm (1' 11")	1,615 mm (5' 4")	29.5 mm (1")	6,150 / 9,500 kg (13,558.4 / 20,943.9 lb)
L3	<ul style="list-style-type: none"> <li>in sand operation</li> <li>in all kind of load/carry operation</li> <li>the L3-tread is not as open as L2 and has consequently less self-cleansing compared with an L2 tyre</li> </ul>		23.5 - 25	16	TL	595 mm (1' 11")	1,615 mm (5' 4")	35 mm (1")	6,150 / 9,500 kg (13,558.4 / 20,943.9 lb)
			23.5 - 25	20	TL	595 mm (1' 11")	1,615 mm (5' 4")	35 mm (1")	7,300 / 10,900 kg (16,093.7 / 24,030.4 lb)
			23.5 - 25	24	TL	595 mm (1' 11")	1,615 mm (5' 4")	35 mm (1")	8,000 / 13,200 kg (17,637 / 29,101 lb)
			23.5 R 25	*	TL	600 mm (2")	1,617 mm (5' 4")	36 mm (1")	7,100 / 12,150 kg (15,652.8 / 26,786.1 lb)
			23.5 R 25	**	TL	600 mm (2")	1,617 mm (5' 4")	36 mm (1")	9,250 / 14,500 kg (20,392.7 / 31,967 lb)
L5	<ul style="list-style-type: none"> <li>in very aggressive material where good protection against cut damages is demanded, e.g. in quarries or mines</li> </ul>		23.5 R 25	*	TL	600 mm (2')	1,704 mm (5' 7")	78 mm (3")	12,150 kg, 10 km/h (26,786.1 lb, 6.2 mph)
			23.5 R 25	**	TL	600 mm (2')	1,704 mm (5' 7")	78 mm (3")	14,500 kg, 10 km/h (31,967.03 lb, 6.2 mph)

Note: The radial tire-load bearing capacity is indicated by the number of stars (\*). More stars, greater radial tire-load bearing capacity. For the specific radial tire sizes listed in the table above, 2 stars (\*\*) represents the maximum radial tire-load bearing capacity.

## ATTACHMENTS

LiuGong attachments with pin-on or quick-coupler ensure high quality. The integrated design of the system creates a perfect match to achieve superior productivity.

Type	Capacity	Width	Height	Digging Depth	Dump Clearance	Dump Reach	Description	Attachment Drawing
General Purpose	2.6 m <sup>3</sup> (3.4 yd <sup>3</sup> )	2,900 mm (9' 6")	1,347 mm (4' 5")	35 mm (1")	3,075 mm (10' 1")	1,008 mm (3' 4")	Anti-Wear Blade with Welded Teeth.	
	3 m <sup>3</sup> (3.9 yd <sup>3</sup> )	2,900 mm (9' 6")	1,303 mm (4' 3")	35 mm (1")	2,983 mm (9' 9")	1,100 mm (3' 7")	Anti-Wear Blade with Bolt-on Cutting Edge and Bolt-on Teeth.	
	3.3 m <sup>3</sup> (4.3 yd <sup>3</sup> )	2,900 mm (9' 6")	1,314 mm (4' 4")	35 mm (1")	2,955 mm (9' 8")	1,129 mm (3' 9")	Bolt-on Cutting Edge; Bolt-on Teeth; Bolt-on Cutting Edge and Bolt-on Teeth.	
	3.5 m <sup>3</sup> (4.6 yd <sup>3</sup> )	2,900 mm (9' 6")	1,382 mm (14' 6")	35 mm (1")	2,877 mm (9' 5")	1,206 mm (3' 12")	Bolt-on Cutting Edge; Bolt-on Teeth.	
Light Material	4.2 m <sup>3</sup> (5.5 yd <sup>3</sup> )	3,168 mm (10' 5")	1,429 mm (4' 8")	67 mm (2")	2,802 mm (9' 2")	1,236 mm (4' 1")	Bolt-on Cutting Edge.	
	4.7 m <sup>3</sup> (6.1 yd <sup>3</sup> )	3,168 mm (6' 5")	1,445 mm (4' 9")	67 mm (2")	2,697 mm (8' 10")	1,338 mm (4' 5")	Bolt-on Cutting Edge.	
	5.6 m <sup>3</sup> (7.3 yd <sup>3</sup> )	3,150 mm (6' 4")	1,561 mm (5' 1")	67 mm (2")	2,733 mm (8' 12")	1,350 mm (4' 5")	Bolt-on Cutting Edge; Bolt-on Cutting Edge and Welded Teeth.	
Rock	2.7 m <sup>3</sup> (3.5 yd <sup>3</sup> )	2,866 mm (9' 5")	1,390 mm (4' 7")	77 mm (3")	2,919 mm (9' 7")	1,096 mm (3' 7")	V-Shape Anti-Wear Blade.	
Grapple	Φ1,000 mm (3' 3")	2,640 mm (8' 8")	1,732 mm (5' 8")	62 mm (2")	2,610 mm (8' 7")	1,678 mm (5' 6")	Aligned Teeth.	
	Φ350 mm (1' 2")	2,600 mm (8' 6")	1,520 mm (5')	62 mm (2")	2,862 mm (9' 5")	1,485 mm (4' 10")	Crossed Teeth.	

# STANDARD EQUIPMENT

## ENGINE

- Cummins B6.7 Engine, EU Stage V, Engine output- rated net power 168 kW (225 hp / 228 ps), air-to-air intercooled, 6 cylinders, 4 stroke
- High Pressure Common Rail
- Exhaust emission control
- DC air filter, fuel filter
- Intelligent Power Control (IPC )
- Hydraulic driven reversible fan
- Grid heater

## TRANSMISSION

- ZF 4BP210 transmission
- Kick-down function, FNR, F4/R3
- Transmission oil level sight gauge
- Secondary oil filter, oil stick
- Remote pressure taps for diagnostics
- Auto shifting mode by speed
- Interlock between parking brake and gear shifting

## AXLE

- ZF wet axle with limited slip differentials
- Wet discs service brake system
- Parking brake service as secondary

## HYDRAULIC SYSTEM

- Two piston pumps with variable displacement. Hydraulic load-sensing according to demand
- Third valve and multipurpose lines
- Single joystick control
- Boom kick-out, automatic
- Bucket positioner, automatic
- Plug at the port of bucket and boom cylinder for pressure check
- Emergency boom lower via pilot accumulator

## STEERING SYSTEM

- Load sensing system with flow amplification and steering priority
- Emergency steering system

## TIRE & RIM

- 23.5R25\*/L3 Radial tire
- Full fender

## CHASSIS FRAME

- Spacious central articulation arrangement with conic bearing
- Articulation locking bar
- Tow hitch
- Rubber cushion articulation stops

## LINKAGE & ATTACHMENTS

- Z-bar linkage

## ELECTRIC SYSTEM

- Two front lights with high/low beam
- Four front headlights on top of cab
- Two rear headlight on top of cab
- Turn signals with flasher
- Batteries, free of maintenance
- Cigarette lighter, 24 V power outlet
- Electric horn
- Front and rear windshield wiper
- Electronic device compartment
- Back-up alarm
- Radio/player with USB port
- Reversing warning light, automatic
- Rotating beacon
- License-plate bracket and light

## GAUGE GROUP

- Engine coolant temperature
- Transmission oil temperature

- Fuel level
- Hour meter
- Voltage
- Brake oil pressure

## INDICATOR GROUP

- Air inlet heater
- Battery charging
- Parking brake applied
- Machine emergent stop
- Power cut-off
- Engine servicing
- Turning lights
- Engine starter running
- Beam of front light

## CAB

- Certified FOPS (ISO 3449) and ROPS (ISO 3471) cab
- Seat - air suspension with 3 inch seatbelt
- 4-way adjustable steering column
- Large curved front glass
- Viscous cab mounts
- Cab fresh air filter
- One interior & dual exterior rear-view mirrors
- Rear-view camera display
- Air conditioner
- Lunch-box/cooler holder
- One beverage holder
- Cigarette lighter
- Cab rear window defroster
- Sun visors
- Fire extinguisher

## OTHERS

- Automatic central lubrication
- Wedge block

# OPTIONAL EQUIPMENT

## ENGINE

- Cold start aid

## TRANSMISSION

- ZF Ergopower 5WG210 transmission with electrical lock up

## AXLE

- ZF wet axle without limited slip differentials

## HYDRAULIC SYSTEM

- Electric Proportional Controller
- Ride control

## TIRE & RIM

- See tires options
- Normal fender
- Tire protective chain

## CAB

- Heated air suspension seat
- Heated external rear view mirrors
- Cab dust removal device
- Front windshield screen (must be mounted at factory)

## LINKAGE & ATTACHMENTS

- Quick coupler
- Additional counterweight
- High/extra-high linkage
- Bolt-on wear-resist blade and teeth
- Rock bucket
- Grapple with aligned or crossed teeth
- Fork
- Snow blade

## OTHERS

- Weight scale (Electric load weigher)
- Hood protective guard



**TRUCK & EQUIPMENT SERVICES SA**  
**17, rue des Martyrs**  
**L-7375 LORENTZWEILER**  
**+352 33 34 35**  
**info@tes.lu**  
**www.tes.lu**

**LG-PB-856H-Stage V-24-21062021-ENG**



**Guangxi LiuGong Machinery Co., Ltd.**

No. 1 Liutai Road, Liuzhou, Guangxi 545007, PR China  
T: +86 772 388 6124 E: overseas@liugong.com  
www.liugong.com

Like and follow us:



The LiuGong series of logos herein, including but not limited to word marks, device marks, letter of alphabet marks and combination marks, as the registered trademarks of Guangxi LiuGong Group Co., Ltd. are used by Guangxi LiuGong Machinery Co., Ltd. with legal permission, and shall not be used without permission. Specifications and designs are subject to change without notice. Illustrations and pictures may include optional equipment and may not include all standard equipment. Equipment and options varies by regional availability.